

WGT.NET.CN

王牌产品系列

中国威高传动



| 型号: 17-167 | Model: 17-167 |
|--------------------|--------------------|
| 输入功率: 0.12-100W | 输入功率: 0.12-100W |
| 最大扭矩: 21-13000 N.m | 最大扭矩: 21-13000 N.m |

1 R系列斜齿轮硬齿面减速机 R Series Helical Gear Units

性能与空间要求的绝佳配比, 全系列扭矩值和转速范围宽, 速比分级精细。

在您的应用场合中能够实现高效率传动。

They feature an ideal ratio between performance and space requirements - also in your application: Twenty frame sizes of the helical gear unit portfolio, with finely stepped torque ratings and gear unit ratios. High efficiency included.



R系列斜齿轮硬齿面减速机

R Series Helical Gear Units

In 90 countries/regions, we have provided more than 160 mechanical products and won praises from more than 2,000 high-quality customers.

在90个国家/地区, 我们提供了160多个机械产品, 赢得了2000多个优质客户的赞誉。

多种型号选择



WGT®





R R 系列斜齿轮硬齿面减速机 R series helical gear hard tooth surface reducer

R系列斜齿轮减速器具有通用性强、组合性好、使用寿命长等特点，具有传动比容易、效率高、振动小、轴径向载荷大等优点，而且还有利于相关齿轮箱设备的定位。

The R series helical gear reducer has the characteristics of strong universality, good combination, and long service life. It has the advantages of easy transmission ratio, high efficiency, low vibration, large radial load on the shaft, and is also conducive to the positioning of relevant gearbox equipment.

| | |
|-------------------|----------------------------|
| 型号: R17~R167 | Model: R17~R167 |
| 传动比: 3.83~229.71 | Ratio: 3.83~229.71 |
| 输入功率: 0.18~160KW | Input Power: 0.18~160KW |
| 输出扭矩: 85~18000N.m | Output Torque: 85~18000N.m |



WGT[®]

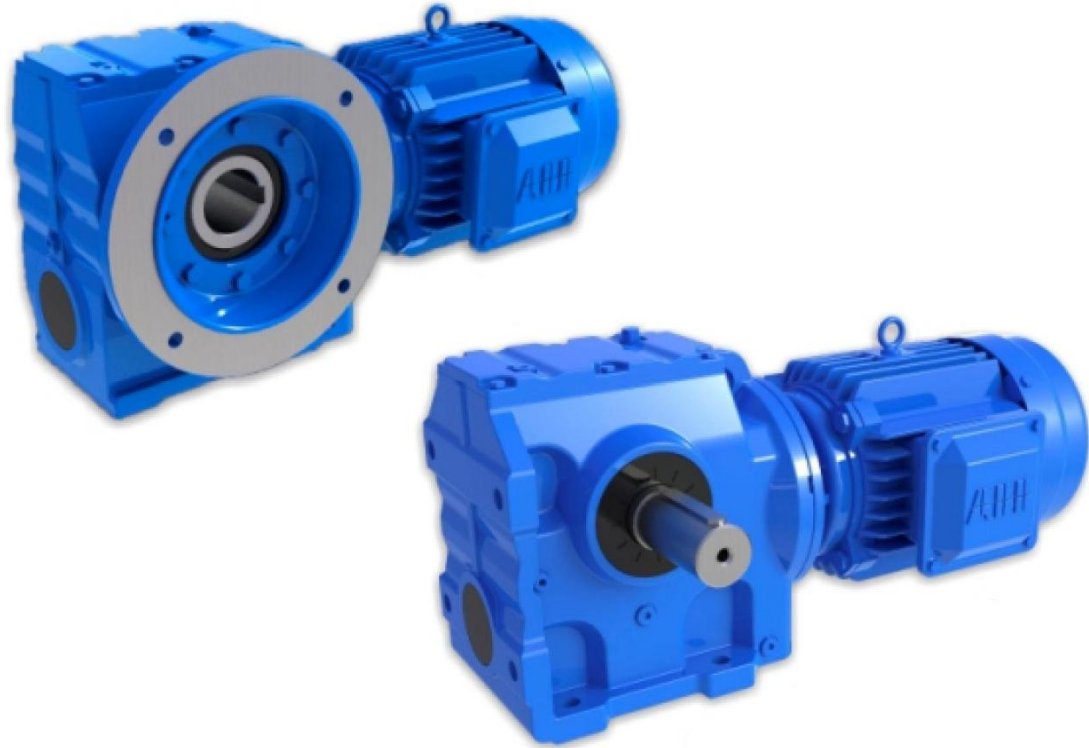

**S**

S 系列斜齿蜗轮蜗杆减速机 S series helical worm gear reducer

斜齿轮蜗轮蜗杆减速机的最大优势就是它的简单机械结构。它的效率远比通常的蜗轮减速机高。而且S系列减速机运行噪音低。

The strength of our helical-worm gear units is their simple mechanical structure. This yields a higher efficiency than pure worm gear units. In addition, the S series gear units are quiet during operation.

| | |
|-------------------|---------------------------|
| 型号: S37~S97 | Model: S37~S97 |
| 传动比: 10.27~230.48 | Ratio: 10.27~230.48 |
| 输入功率: 0.18~22KW | Input Power: 0.18~22KW |
| 输出扭矩: 90~6500N.m | Output Torque: 90~6500N.m |



WGT®





K K 系列斜齿螺旋锥齿轮减速机 K series helical bevel gear reducer

斜齿轮锥齿轮减速机采用零磨损设计，维护少，运行寿命长，从技术上来说是非常经济的直角减速机。它的效率非常高，是实实在在的节能高手。

Thanks to their long maintenance-free operating life and their wear-free gearing, our helical-bevel gear units are—technically speaking—economical right-angle gear units. Their high level of efficiency, however, makes them real energy savers.

| | |
|--------------------|----------------------------|
| 型号: K37~K187 | Model:K37~K187 |
| 传动比: 5.36~180.78 | Ratio:5.36~180.78 |
| 输入功率: 0.18~200KW | Input Power:0.18~200KW |
| 输出扭矩: 200~50000N.m | Output Torque:200~50000N.m |



WGT®



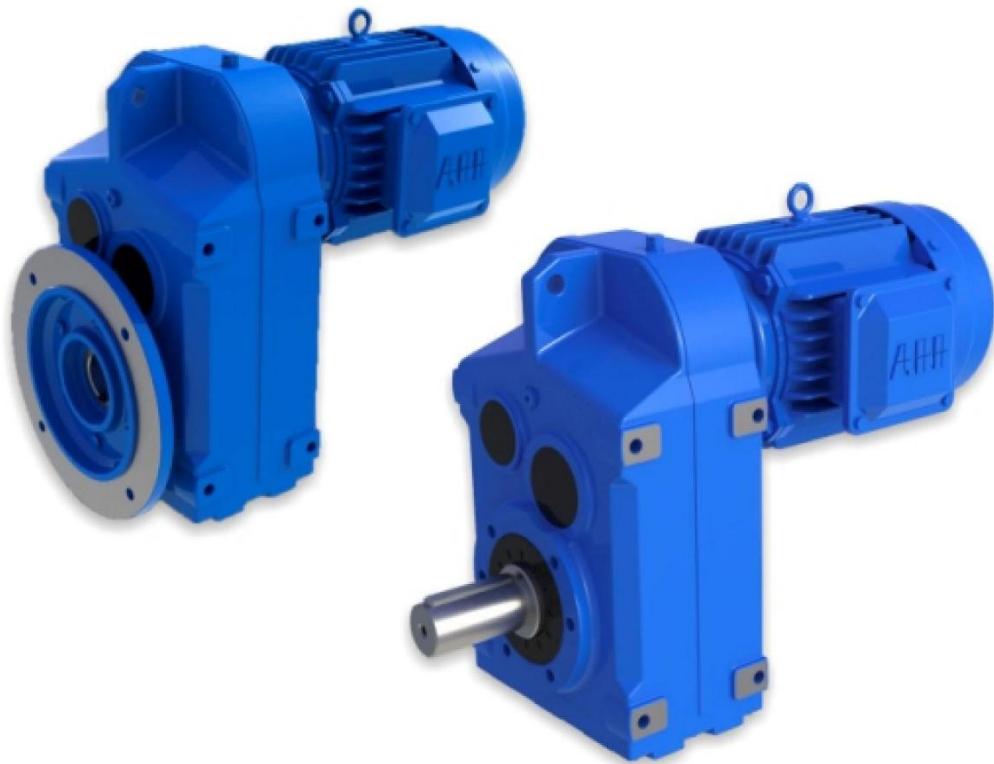

F 系列平行轴斜齿轮减速机

F series parallel axis helical gear reducer

具有通用性强、组合性好、承载能力强的特点。具有传动比容易、效率高、振动小、轴径向载荷大的优点。该系列不仅可以与各种减速器和齿轮箱配合使用，满足要求，而且还有利于相关齿轮箱设备的定位。

It has the characteristics of strong universality, good combination, and strong carrying capacity. It has the advantages of easy transmission ratio, high efficiency, low vibration, and large radial load on the shaft. This series can not only be used in conjunction with various reducers and gearboxes to meet requirements, but also facilitate the positioning of related gearbox equipment.

| | |
|---------------------|---------------------------|
| 型号: F17~F167 | Model:F17~F167 |
| 传动比: 3.83~229.71 | Ratio:3.83~229.71 |
| 输入功率: 0.18 ~ 160KW | Input Power:0.18~160KW |
| 输出扭矩: 85 ~ 18000N.m | Output Torque:85~18000N.m |



WGT[®]

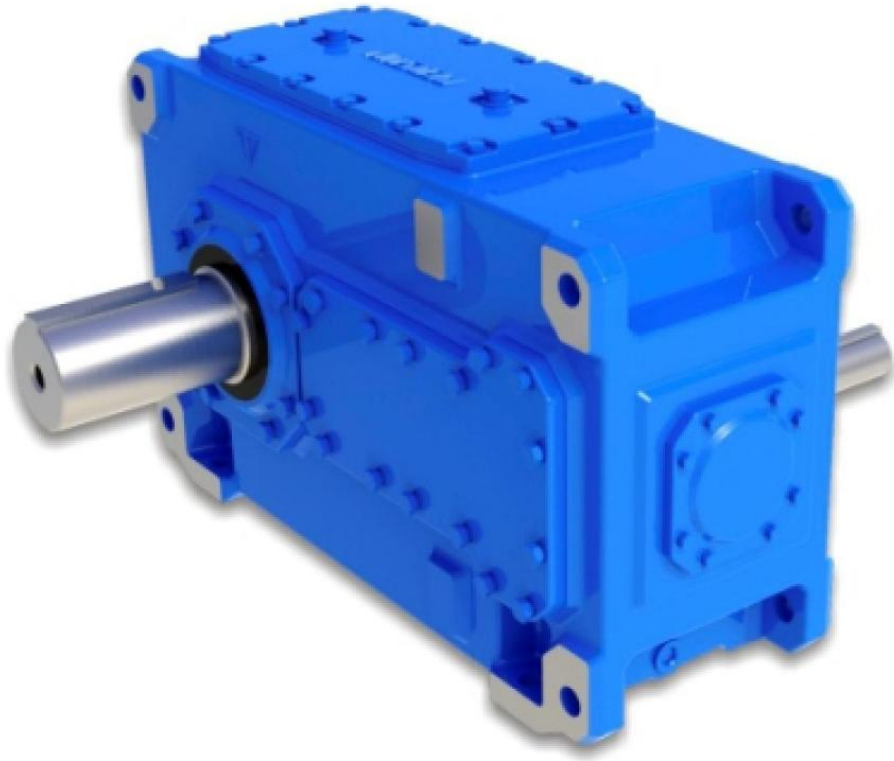

**HB**

HB 系列标准工业齿轮箱

HB series standard industrial gearbox

HB齿轮箱有平行轴、直交轴两种传动类型，传动级数1-4级。采用吸音箱体结构、圆柱齿轮和螺旋锥齿轮均采用先进的磨齿工艺，使整机的温升、噪声降低，传动的可靠性得到提高，传递功率增大。

The HB gearbox has two types of transmission: parallel axis and orthogonal axis, with transmission stages ranging from 1 to 4. Adopting a sound-absorbing box structure, advanced gear grinding technology is used for both cylindrical and spiral bevel gears, which reduces the temperature rise and noise of the entire machine, improves the reliability of the transmission, and increases the transmission power.

| | |
|--------------------|----------------------------|
| 型号: 3~26 | Model:3~26 |
| 传动比: 1.25~450 | Ratio:1.25~450 |
| 输入功率: 4.2~6958KW | Input Power:4.2~6958KW |
| 输出扭矩: 6.2~1030kN.m | Output Torque:6.2~1030kN.m |



WGT®





P P 系列行星齿轮减速机 P series planetary gear reducer

P系列行星齿轮减速机采用渐开线行星齿轮传动，具有重量轻、体积小、传动比范围大、效率高、运转平稳、噪声低适应性强等特点。箱体内的太阳轮、行星轮、内齿圈均采用渗碳淬火处理，得到高硬耐磨表面，热处理后全部磨齿，降低了噪音，提高了整机的效率及使用寿命。

The P series planetary gear reducer adopts involute planetary gear transmission, which has the characteristics of light weight, small volume, large transmission ratio range, high efficiency, smooth operation, low noise, and strong adaptability. The sun gear, planetary gear, and inner gear ring inside the box are all carburized and quenched to obtain a high hardness and wear-resistant surface. After heat treatment, all teeth are ground to reduce noise and improve the efficiency and service life of the entire machine.

| | |
|-------------------|--------------------------|
| 型号: 9~34 | Model:9~34 |
| 传动比: 25~4000 | Ratio:25~4000 |
| 输入功率: 0.4~14000KW | Input Power:0.4~14000KW |
| 输出扭矩: 22~1920N.m | Output Torque:22~1920N.m |



WGT®



**WP**

WP 系列蜗轮蜗杆减速机 WP series worm gear reducer

WP系列减速机的蜗杆采用45#优质钢经热处理加工制造，蜗轮用锡青铜铸制而成，耐磨性能良好，尤其在承载能力上更加明显，蜗轮蜗杆减速机主要适用于塑料、冶金、饮料、矿山、起重运输、化工建筑等各种机械设备的减速传动。

The worm of the WP series reducer is made of 45# high-quality steel and processed by heat treatment. The worm wheel is made of tin bronze. It has good wear resistance, especially in the bearing capacity. The worm gear reducer is mainly suitable for plastic, metallurgy, and beverages, Mining, lifting and transportation, chemical construction and other mechanical equipment deceleration transmission.

单级速比 Single-stage ratio 115-1160

万能速比 Universal ratio 115-1160

双级速比 Two-stage ratio 1/100-1/3600



WGT[®]



**RV****RV 系列蜗轮蜗杆减速机
RV series Worm Reducer**

RV蜗轮蜗杆减速器是精心设计和不断改进的产品。其主要特点是优质铝合金、重量轻、无锈蚀、输出扭矩大、运行稳定、噪音低、散热好、外观美观、耐用。使用寿命短，适用于所有安装位置。

The RV worm gear reducer is a carefully designed and continuously improved product. Its main characteristics are high-quality aluminum alloy, light weight, rust free, high output torque, stable operation, low noise, good heat dissipation, beautiful appearance, and durability. Short service life, suitable for all installation positions.

| | |
|---------------------------|---------------------------------|
| 型号: 25~130 | Model:25~130 |
| 传动比: 7.5~100 | Ratio:7.5~100 |
| 输入功率: 0.18 ~ 100KW | Input Power:0.18~100KW |
| 输出扭矩: 2.6~610N.m | Output Torque:2.6~610N.m |



WGT®





X系列: 1、2、3、4、5、6、7、8、9、10、11

B系列: 0、1、2、3、4、5、6、7、8

两级: 42、53、63、74、84、85、95、106、116、117

三级: 642、742、842、852、853、952、953、1063、1164、1174

BX

BX 系列摆线针轮减速机 **BX series cycloidal pinwheel reducer**

机型分为: X系列、B系列两大类。
传动形式分为: 单级、双级、三级。
结构型式分为卧式、立式、双轴型、直联型四种, 可供用户选用满足各种不同需求。

The models are divided into: X series, B series two categories. The drive into the form: single-stage, two-stage, three.
The structure type is divided into horizontal, vertical, double-axle, four direct linking, available for users to choose to meet various needs.



WGT[®]

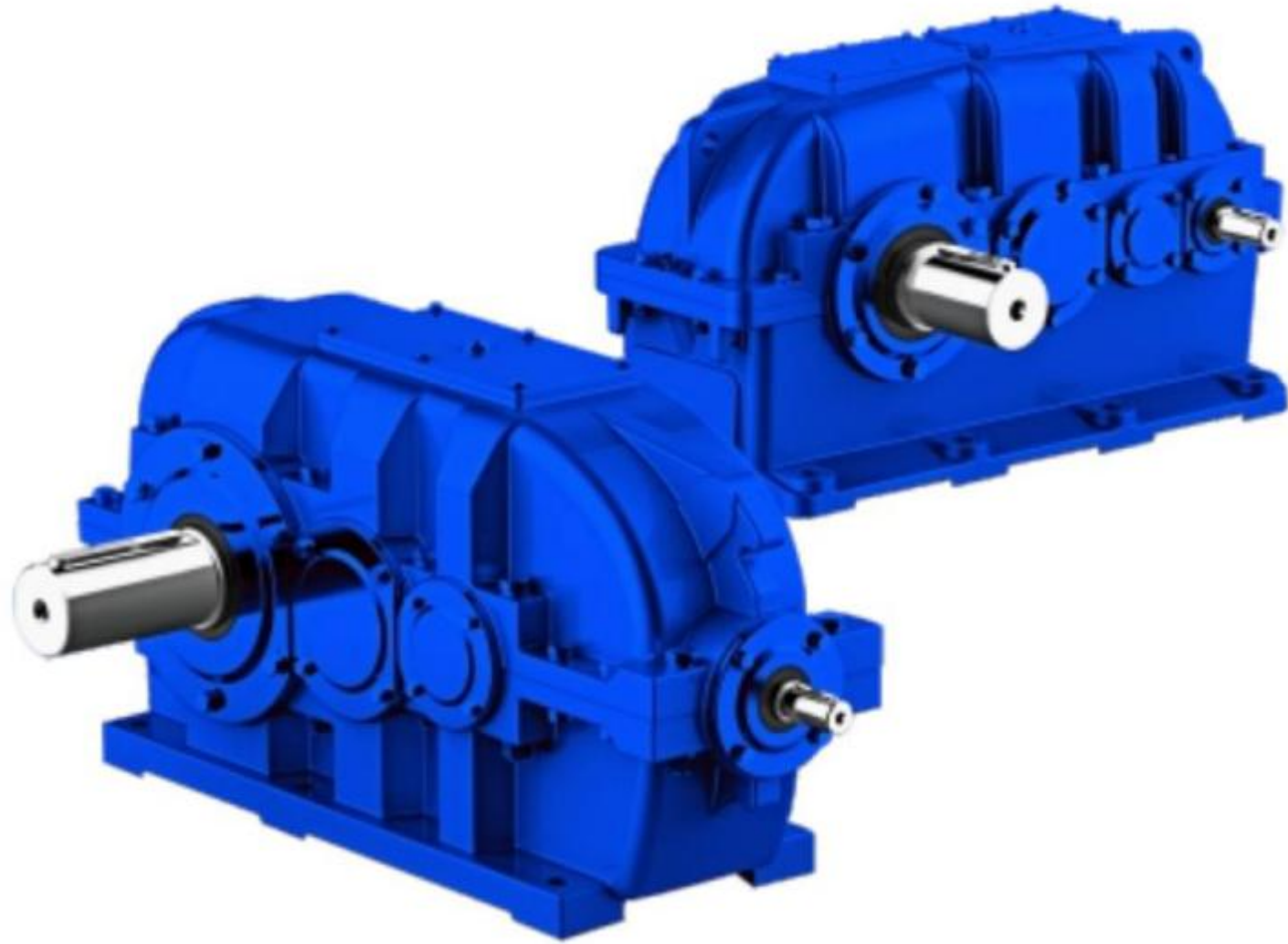

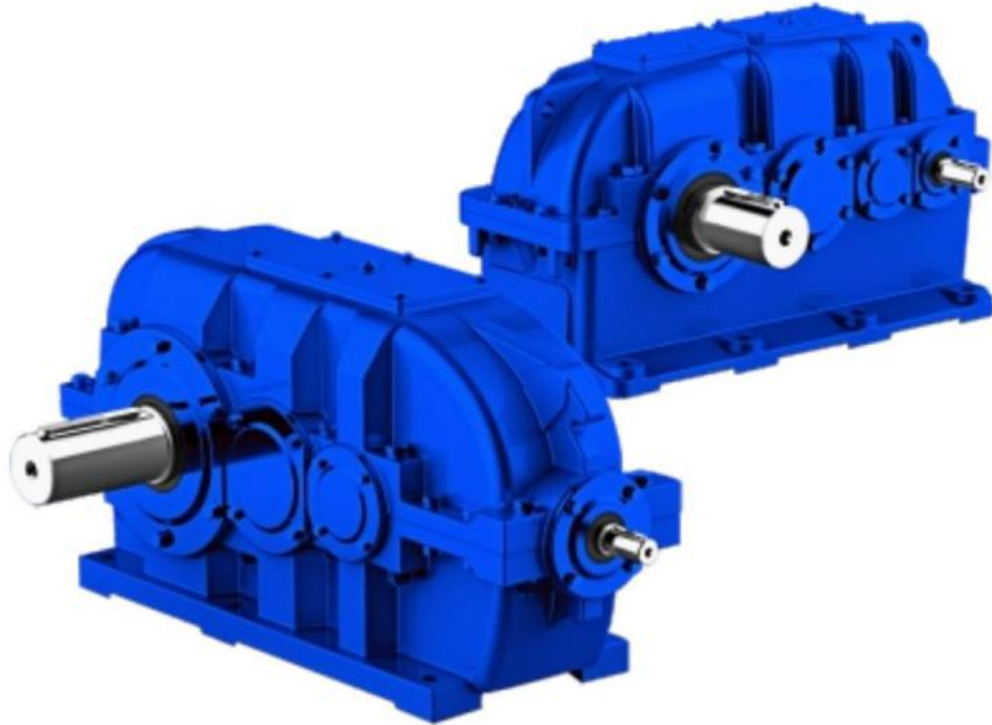

ZDY DBY 圆锥圆柱齿轮减速机 ZDY DBY bevel cylindrical gear reducer

圆柱齿轮减速机，齿轮渗碳，淬火，磨削，承载力高，噪音低；主要用于皮带输送机和各种运输机械。优点是：输入轴和输出轴垂直布置在驱动装置中，承载能力强，使用寿命长，体积小，效率高，重量轻。

Cylindrical gear reducer, gear carburizing, quenching, grinding, high bearing capacity, low noise; mainly used for belt conveyors and various transportation machinery. The advantages are: the input shaft and the output shaft are arranged vertically in the drive device, with strong bearing capacity, long service life, small size, high efficiency and light weight.

| | | | | |
|-----|----|--------------------|----------|----|
| ZDY | 速比 | ratio Double stage | 8-14 | 双级 |
| ZDY | 速比 | ratio Three | 16-50 | 三级 |
| DBY | 速比 | Single stage | 1.25-6.3 | 单级 |
| DBY | 速比 | ratio Double stage | 6.30-20 | 双级 |
| DBY | 速比 | ratio Three | 22.4-100 | 三级 |



WGT[®]

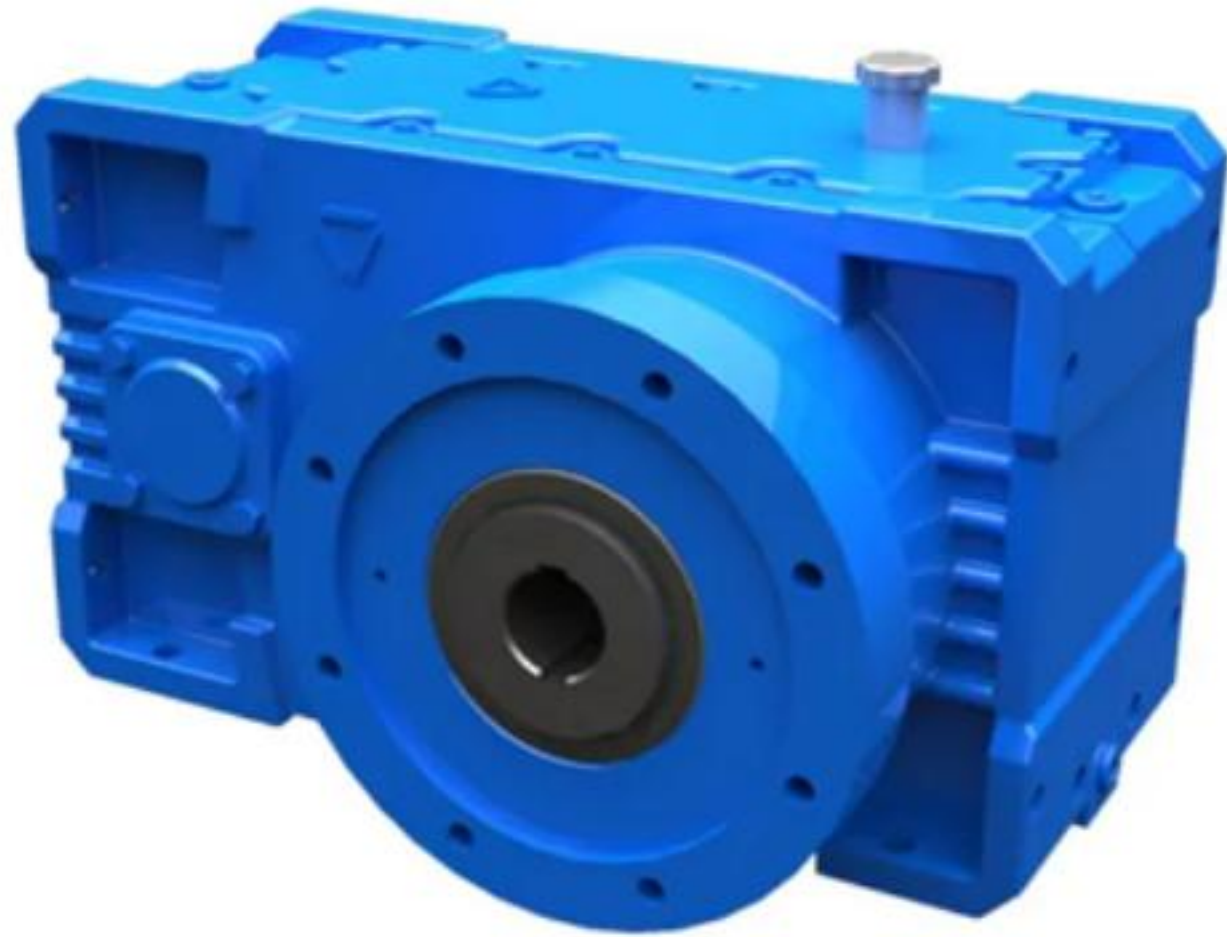

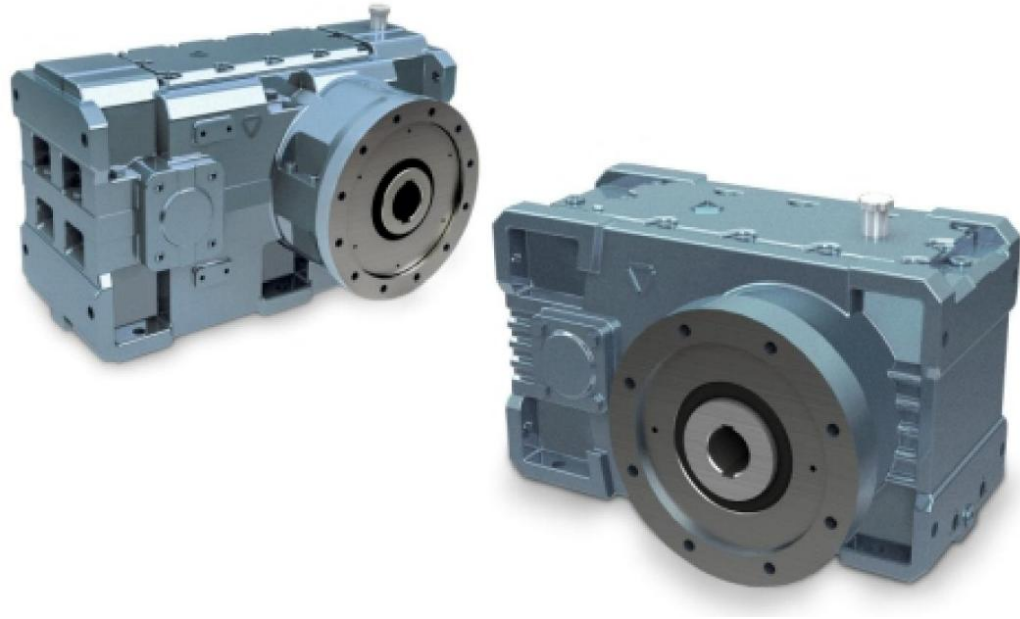

ZL ZLYJ 单螺杆挤出机专用减速机 ZLYJ single screw extruder dedicated reducer

塑料螺杆挤出机采用轻量化设计，造型美观，密封性好，更高效。具有设计结构紧凑、承载能力强、传动平稳、低噪声等优点。零件由高强度合金钢制成，齿轮经过渗碳处理，淬火和齿轮磨削。

The plastic screw extruder adopts a lightweight design, with beautiful appearance, good sealing performance, and more efficiency. It has the advantages of compact design structure, strong load-bearing capacity, stable transmission, and low noise. The parts are made of high-strength alloy steel, and the gears are carburized, quenched, and ground.

| | |
|----------------------------|--|
| 型号: 112~450 | Model:112~450 |
| 传动比: 8~20 | Ratio:8~20 |
| 输入功率: 4.4~188KW | Input Power:4.4~188KW |
| 输出扭矩: 0.65~11.1kN.m | Output Torque:0.65~11.1kN.m |

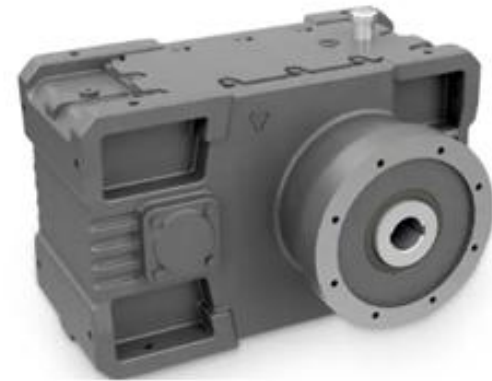

WGT®



**RXG****RXG 悬挂式齿轮减速机**
RXG suspension gear reducer

RXG 是威高传动公司长期以来采石场和矿山应用的畅销产品。它采用立式三级传动设计，主要为行车配套，具有高可靠性和低维护。在倾斜输送机的情况下，可装退回装置来防止反向驱动。

The RXG series has long been a best-selling product for quarry and mining applications. Adopting a vertical three-level transmission design, mainly used as a supporting device for driving, with high reliability and low maintenance. In the case of inclined conveyors, a return device can be installed to prevent reverse drive.

| | |
|---------------------------|-----------------------------------|
| 型号: 35~125 | Model:35~125 |
| 传动比: 5~31 | Ratio:5~31 |
| 输入功率: 2.5~226KW | Input Power:2.5~226KW |
| 输出扭矩: 420~17000N.m | Output Torque:420~17000N.m |





**SMR****SMR轴装式斜齿轮减速机
SMR shaft mounted helical gear reducer**

轴装式减速机结构紧凑、承载能力大、效率高、噪声低等性能可靠，广泛应用于矿山、冶金等行业。齿轮采用高强度合金钢材料，渗碳淬火，磨齿工艺。逆止器可用于不能反转的使用条件，扭力臂可用来安装调整减速机的空间位置及皮带的松紧。

The axle mounted reducer has a compact structure, large bearing capacity, high efficiency, low noise, and reliable performance, widely used in industries such as mining and metallurgy. The gears are made of high-strength alloy steel material, carburized and quenched, and undergo gear grinding process. The backstop can be used for non reversible usage conditions, and the torque arm can be used to install and adjust the spatial position of the reducer and the tightness of the belt.

| | |
|-----------------------|----------------------------|
| 型号: A B C D E F G H J | Model: A B C D E F G H J |
| 传动比: 5:1~13:1或20:1 | Ratio: 5:1~13:1/20:1 |
| 输入功率: 0.29~134.2KW | Input Power: 0.29~134.2KW |
| 输出扭矩: 256~7449N.m | Output Torque: 256~7449N.m |



WGT[®]

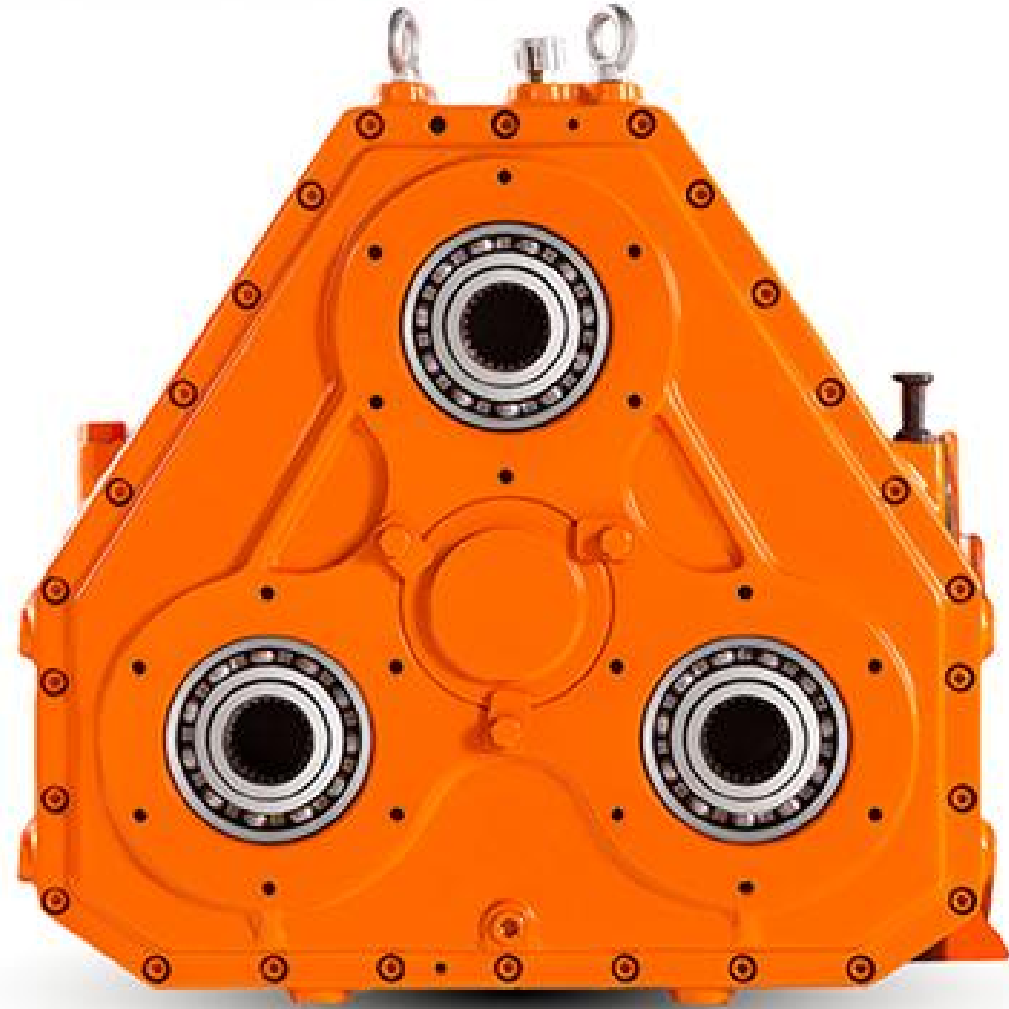

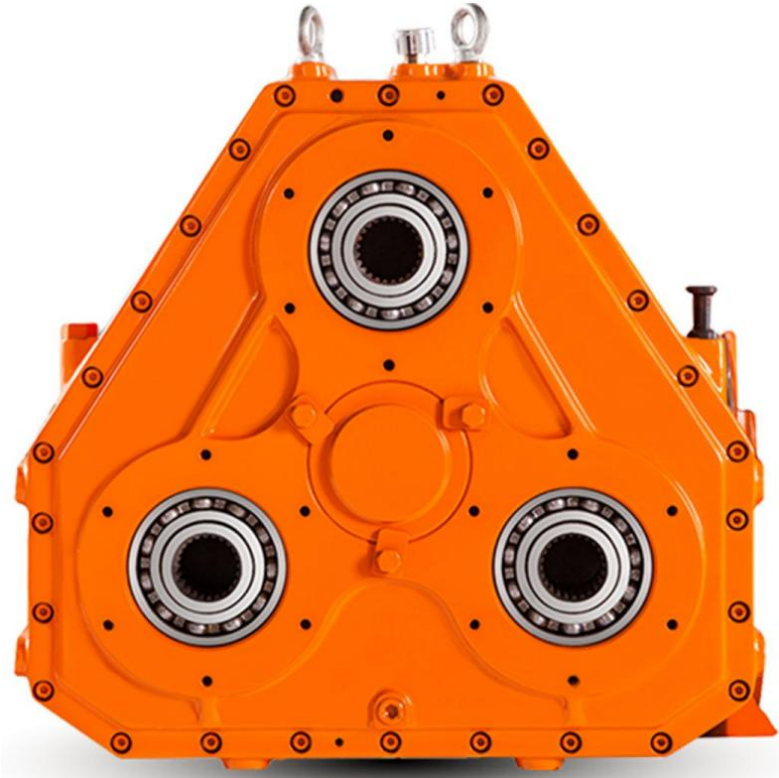
**BQ**

BQ 系列分动箱泵驱动装置

BQ series transfer case pump drive device

BQ系列分动箱是将发动机的动力进行分配的装置。它采用标准化模块设计，精密铸造壳体、高精度齿轮、进口轴承、进口轴承密封件、高弹联轴器等与SAE标准发动机飞轮连接。箱体内采用特殊油路设计，确保充分的润滑冷却效果

The BQ series transfer box is a device that distributes the power of the engine. It adopts a standardized modular design, with precision casting shells, high-precision gears, imported bearings, imported bearing seals, high elasticity couplings, etc. connected to SAE standard engine flywheels. The box body adopts a special oil circuit design to ensure sufficient lubrication and cooling effect.

| | |
|----------------------------|-------------------------------------|
| 型号: BQ126~BQW452 | Model: BQ126~BQ452 |
| 传动比: 0.57~1.13 | Ratio: 0.57~1.13 |
| 输入功率: 260KW~1600KW | Input Power: 260KW~1600KW |
| 输出扭矩: 1560~7966 N.m | Output Torque: 1560~7966 N.m |



WGT[®]





| | |
|--------------------|----------------------------|
| 型号: T2~T25 | Model:T2~T25 |
| 传动比: 1~5 | Ratio:1~5 |
| 输入功率: 0.12~300KW | Input Power:0.12~300KW |
| 输出扭矩: 7.15~5713N.m | Output Torque:7.15~5713N.m |



T 系列螺旋锥齿轮转向箱

T Series Spiral Bevel Steering Box

T系列一级螺旋锥齿轮变速箱是标准化的，提供单轴、双水平轴、单垂直轴和双垂直轴。螺旋锥齿轮可以前进和后退，具有低速或高速传动，低噪音、低振动和高耐久性。T系列换向器具有转向功能，可以随着输入轴旋转方向的改变而改变输出轴。

The T-series primary spiral bevel gear transmission is standardized and offers single axis, dual horizontal axis, single vertical axis, and dual vertical axis. Spiral bevel gears can move forward and backward, with low or high-speed transmission, low noise, low vibration, and high durability.

The T series commutator has a steering function, which can change the output shaft as the direction of input shaft rotation changes.





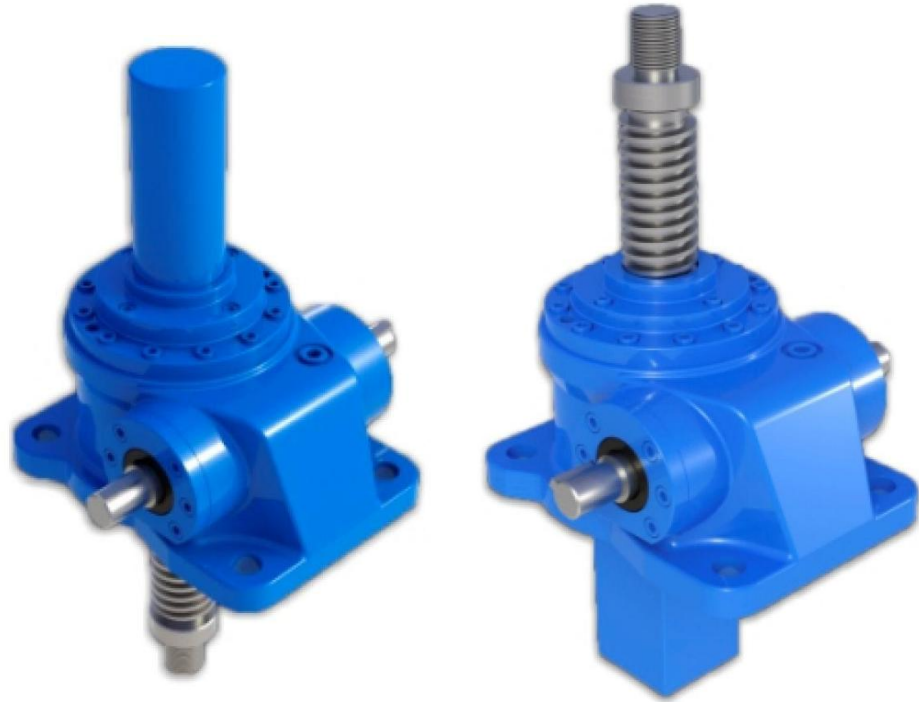

JW SWL 蜗轮蜗杆升降机 JW SWL Worm Gear Elevator

JW系列蜗轮蜗杆升降机是基本的起重部件，它具有起重、下降、前进和转动功能。结构紧凑、体积小、重量轻，安装方便，灵活可靠。性能强，使用寿命长等优点，可由电机或其他动力源直接驱动，也可手动操作。

The JW series worm gear elevator is a basic lifting component that has functions of lifting, lowering, advancing, and rotating. Compact structure, small size, light weight, convenient installation, flexible and reliable. Strong performance, long service life, and other advantages, can be directly driven by a motor or other power source, or can be manually operated.

| | |
|-------------------|-------------------------|
| 型号: 010~1000 | Model:010~1000 |
| 传动比: 6~32 | Ratio:6~32 |
| 输入功率: 0.18~16.3KW | Input Power:0.18~16.3KW |
| 起升力: 2.5吨~120吨 | Lift Capacity:2.5T~120T |



WGT[®]



WGT®

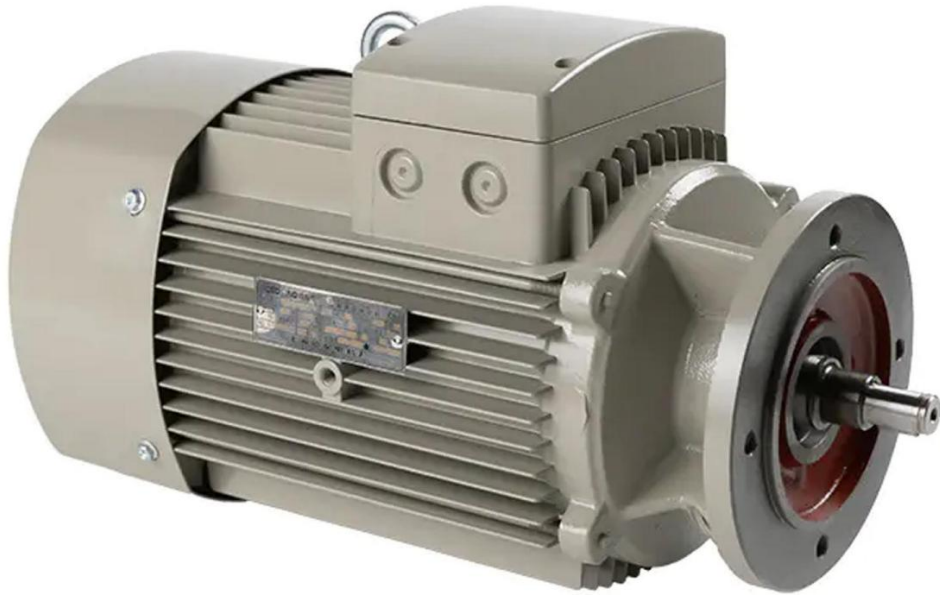

型号大类:

**YE2、YE3、YVF2、YS、YB、YEJ YB2、
YVP、YTJK、FTJK、YY、YL**

[Supply Chain Alliance] MOTOR

DEDONG 德东
中德合资

新菱电机
XINLING MOTOR

YINDA

M

**电机系列[供应链联盟产品]
[Supply Chain Alliance]
MOTOR**

**YE2系列超高效率电机； YE3系列超高效率电机
YVF2系列变频调速电机； YB系列防爆电机
YY系列单相电容电机； YL系列双值电容电机**

**YE2 series ultra high efficiency motor
YE3 series ultra high efficiency motor
YVF2 series variable frequency motor
YB series explosion-proof motor
YY series single-phase capacitor motor
YL series dual value capacitor motor**



WGT[®]

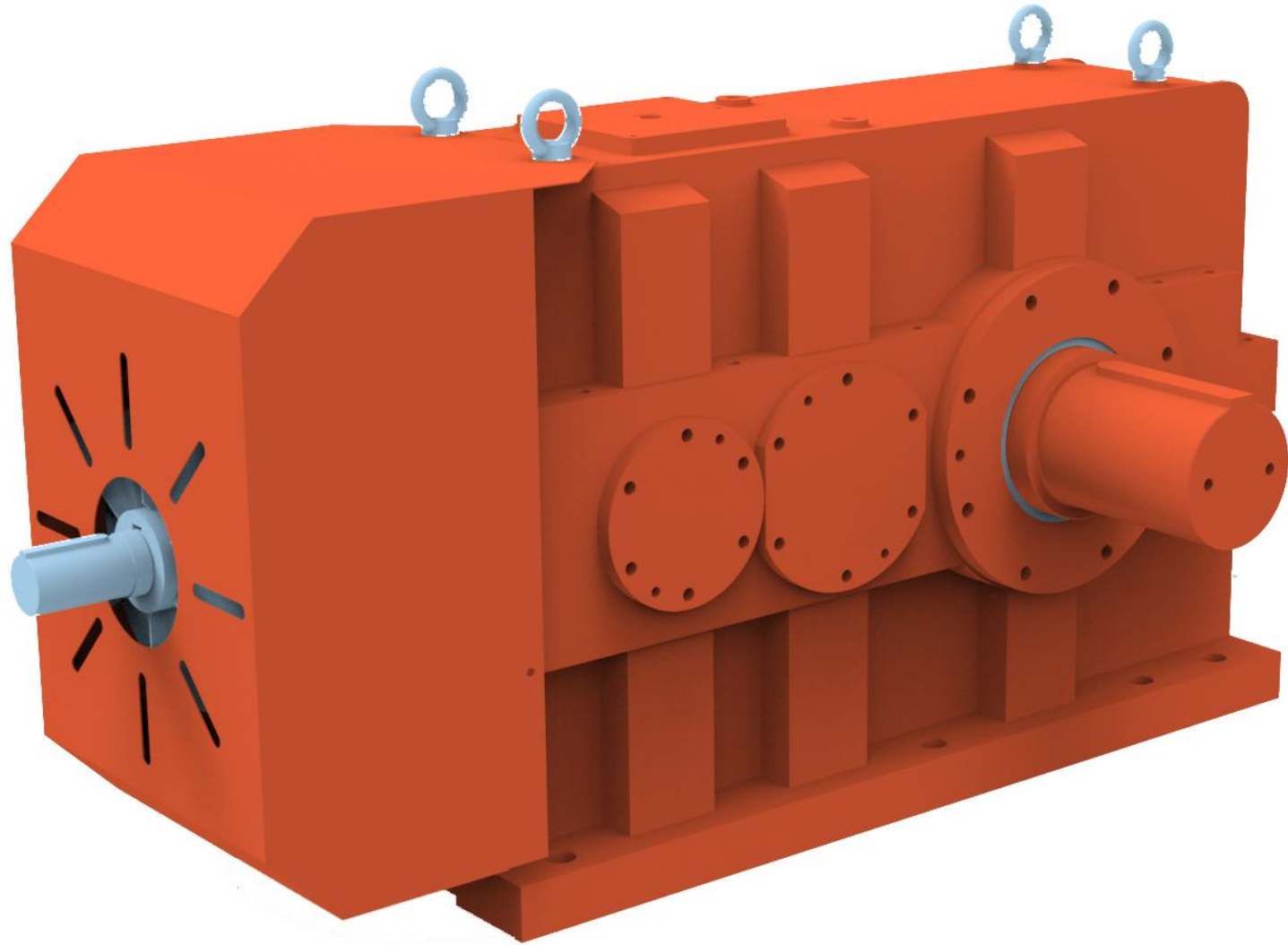

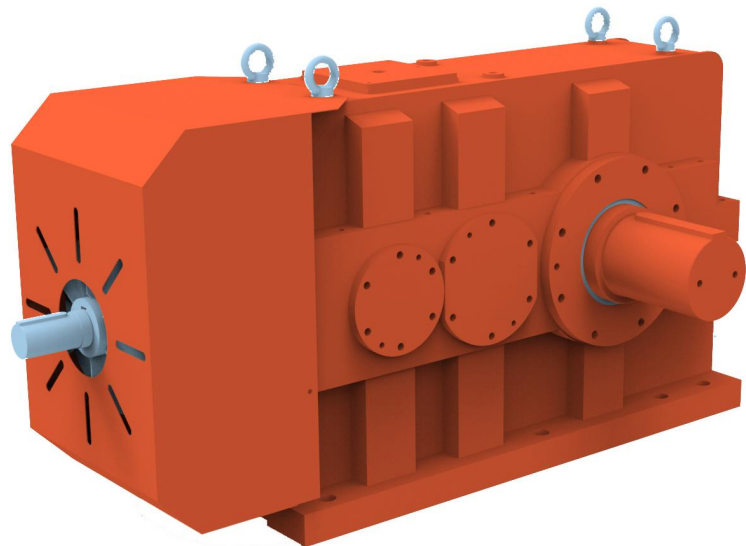
**M/MC**

M/MC 系列工业齿轮箱

M/MC series industrial gearbox

WGT M/MC系列专利齿轮箱是工业齿轮箱具有：大扭矩、高负载、高效率、高寿命的特点。备有单或双输入、输出轴端，结构易于更改，并可实现水平、垂直多种安装形式。

是更换SEW M/MC系列工业变速箱的备选方案

The WGT M/MC series patented gearbox is an industrial gearbox with the characteristics of high torque, high load, high efficiency, and long service life. Equipped with single or dual input and output shaft ends, the structure is easy to change and can be installed in various horizontal and vertical forms. It is an alternative solution to replace the SEW M/MC series industrial gearbox

| | |
|---|--|
| M系列型号：10~90 MC系列型号：02~09 | M series models: 10~90 MC series models: 02~09 |
| M系列传动比：6~1800 MC系列传动比：7.1~112 | M series transmission ratio: 6-1800 MC series transmission ratio: 7.1~112 |
| M系列输入功率：4.2~6958KW MC系列输入功率：4.2~1000KW | M series input power: 4.2~6958KW MC series input power: 4.2-1000KW |
| M系列输出扭矩：30~186000N.m MC系列输出扭矩：30~65000KW | M series output torque: 30~186000N. m MC series output torque: 30~65000KW |

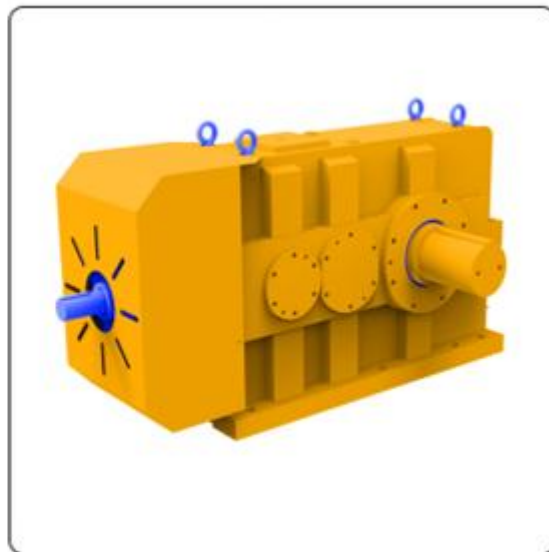
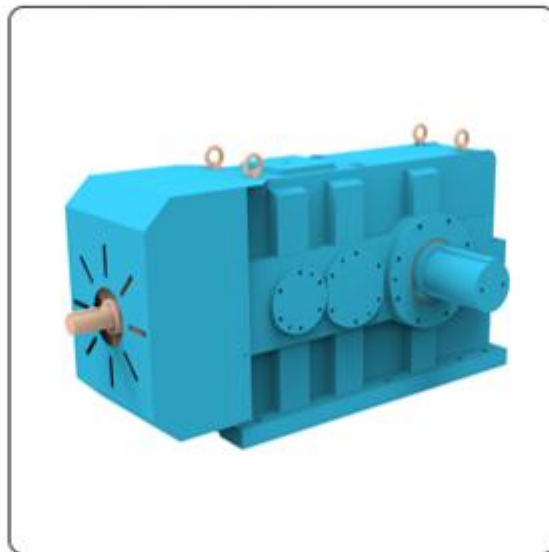
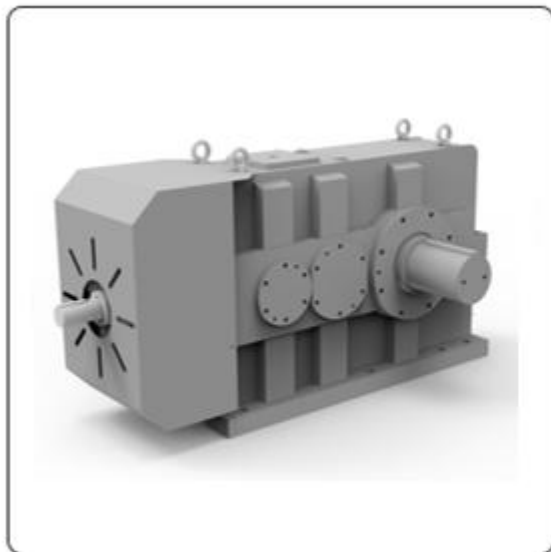
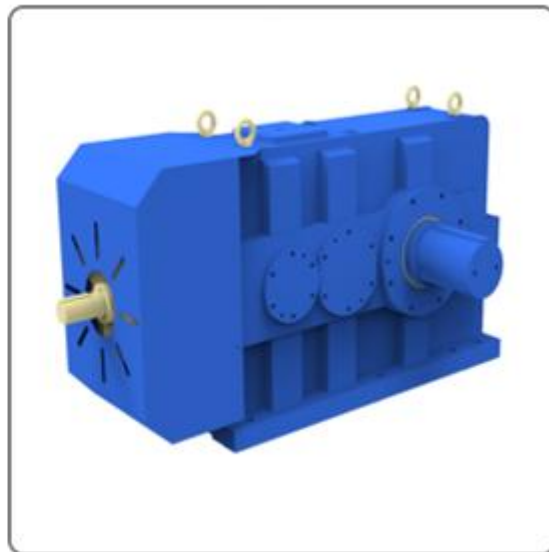
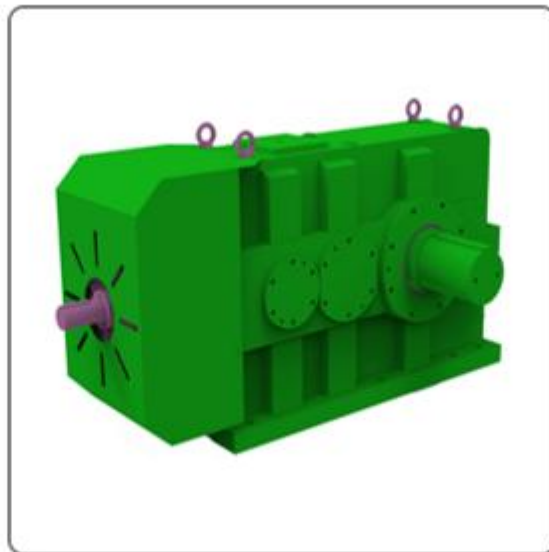
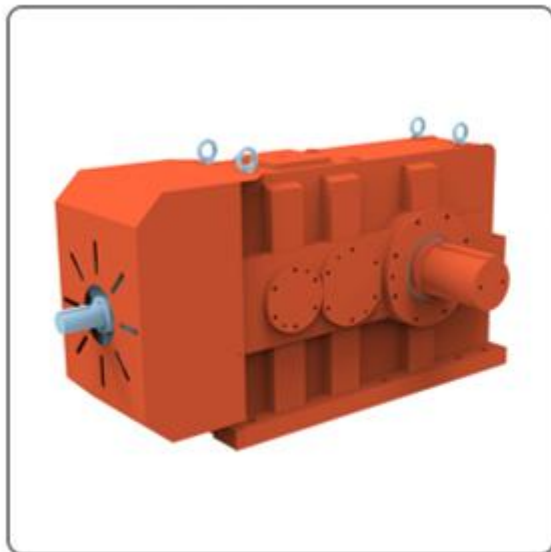

第 59662792 号



商标注册证

WGT

核定使用商品/服务项目（国际分类：7）
第7类：农业机械；脱粒机；起动机（提升装置）；内燃机（非陆地车辆用）；风力动力设备；离心机（截止）

注册人 杭州威高传动机械有限公司

注册地址 浙江省杭州市西湖区三墩镇西园路10号B207室

注册日期 2022年06月14日 有效期至 2032年06月13日

局长 申长雨



发证机关

第 26287718 号



注册证

发证机关



重合同守信用

杭州威高传动

AAA



Enterprise credit rating

This is to certify that

Unified Social Credit Code: 9133010659958569X7

Hangzhou Weigao Transmission Machinery Co., Ltd

Address: Room B207, No. 10, Xiyuan Road, Sandun Town, Xihu District, Hangzhou City, Zhejiang Province

According to the enterprise credit record, enterprise quality, financial situation, development prospect and various possible risks, combined with the current situation of the industry, this paper makes an objective, scientific and fair assessment of its credit situation, and determines the enterprise qualification grade as follows:

AAA

Rating basis: Q/YDQJ001-2020 enterprise credit evaluation system standard

Credit certificate number: YDQJ9693T366X554RDX

Certificate valid date: Oct 25, 2021 - Oct 24, 2024

China Bidding website: www.cebid.org.cn

Credit publicity platform: www.chinaxy315.com

Filing of rating standards: China National Standardization Management Committee (www.qbz.org.cn)



Certificate Query QR Code Rating Agency: Yiding International Credit Rating Agency Ltd.